

# Instruction LED WHITE POSITION LIGHT



Hassellunden 16  
2765 Smørum  
Denmark  
www.dcscandinavia.dk  
info@dcscandinavia.dk

E mark no. : 02 A (E1) 3779  
Voltage : 12 Volt DC  
Power : 5W

Patent pending  
Europe Design protected  
EF-design: 002292524

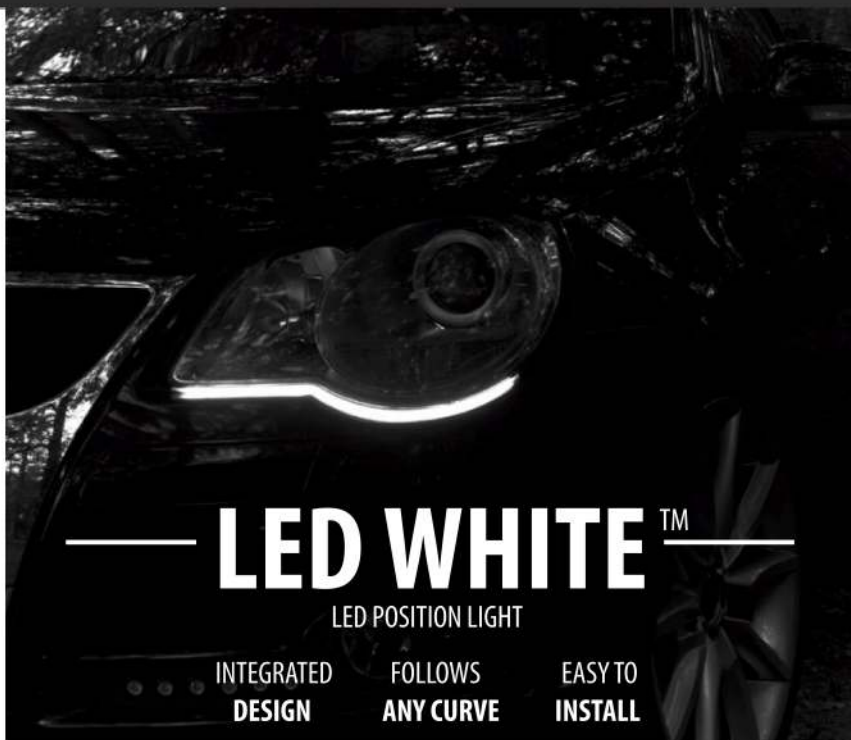

## LED WHITE™

LED POSITION LIGHT

INTEGRATED  
DESIGN

FOLLOWS  
ANY CURVE

EASY TO  
INSTALL



ECE R48



§

This product refer to EU regulation ECE R48 R7  
The installer have the full responsibility of correct  
installation to the specific car.

Type of model

UNIVERSIAL

Description

LED WHITE POSITION LIGHT

Partnumber

DCS-20DAN-T2-375GL



**DK**

- Det skal understreges, at montering, der udføres af en ikke-kvalificeret montør, medfører bortfald af enhver ret til erstatning særligt i forbindelse med erstatningskrav, der måtte opstå i kraft af loven om produktansvar.

**GB**

- We would expressly point out that assembly not carried out properly by a competent installer will result in cancellation of any right to damage compensation, in particular those arising by virtue of the product liability act.

**DE**

- Beachten Sie bitte, dass bei Schäden in Folge unsachgemäßen Einbaus sämtliche Garantieansprüche erlöschen, insbesondere solche, die das Produkthaftungsgesetz betreffen.

**FR**

- Nous tenons à insister tout particulièrement sur le fait que si ce produit n'est pas correctement assemblé par un technicien compétent, aucun droit de compensation ne sera recevable en cas de dommages, notamment les droits en vertu de la loi concernant la responsabilité à l'égard des produits.

**NL**

- We zouden expliciet willen benadrukken dat installatie die niet correct wordt uitgevoerd door een bekwaame installateur kan leiden tot het vervallen van elk recht op schadecompensatie, vooral de compensatie op basis van de productaansprakelijkheidsvereenkomst.

**SE**

- Vi vill uttryckligen meddela att montering som inte görs fackmannamässigt av en kompetent montör, kommer att häva rätten till kompensation för skador, speciellt rättigheter enligt lagen om produktansvar.

**CZ**

- Upozornujeme, že instalace provedená nesprávně nebo nekompetentní osobou, ruší veškerá práva na kompenzaci škod, obzvláště způsobených poruchou produktu.

**FI**

- Jos asennuksen suorittaa joku muu kuin pätevä ammattilainen, tämä kumooa asiakkaan oikeuden vahingonkorvauksiin, erityisesti sellaisiin, jotka perustuvat tuotevastuulakiin.

**NO**

- Vi bemerker at montasje som ikke utføres korrekt, av en kompetent installatør, vil resultere i annullering av all rett til erstatning for enhver skade, spesielt de som oppstår av arten produktansvar.

- Sættenes indhold og monteringsvejledninger kan ændres uden varsel, og vejledningerne skal derfor læses og forstås, før monteringen påbegyndes.

- Contents of these kits and their fitting manuals are subject to alteration without notice, please ensure that these instructions are read and fully understood before commencing installation.

- Das Recht zu Änderungen an Inhalt von Montagesatz und Einbauanleitungen ohne Vorankündigung bleibt vorbehalten. Lesen Sie vor dem Einbau diese Anleitung sorgfältig und gewissenhaft durch.

- Le contenu de ces kits, ainsi que des guides de montage qui les accompagnent est sujet à modifications sans préavis ; lisez attentivement ces instructions avant de procéder à l'installation.

- De inhoud van deze kits en de installatiehandleidingen kunnen worden gewijzigd zonder kennisgeving. Zorg er dus voor dat u deze instructies hebt gelezen en volledig begriipt voordat u met de installatie begint.

- Innehållet i dessa satser och deras bruksanvisningar kan komma att ändras utan föregående meddelande. Vänligen läs dessa anvisningar noga innan du påbörjar monteringen.

- Obsah těchto sad a návody na jejich montáž podléhají změnám bez předchozího upozornění. Prosím, ujistěte se, že jste si pokyny před instalací přečetly a dostatečně jim rozumíte.

- Kiinnitysosan sisältöä ja asennusoppaita voidaan muuttaa siitä etukäteen ilmoittamatta. Asiakkaan tulee ennen asennuksen aloittamista perehtyä huolellisesti näihin ohjeisiin.

- Innholdene i disse sett og deres monteringsanvisninger kan endres uten forvarsel. Vennligst påse at disse instruksjonene leses grundig og er forstått innen installasjonen startes.

# KIT CONTENTS

## LED WHITE STRAP

DCS20DAN-T2-375GL

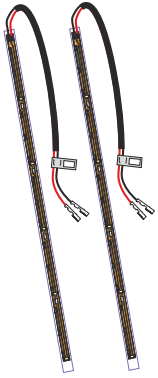

Quantity=2



Tape/ Cleaner

Quantity=1

## INSTALLATION FITTINGS

DCS20DAN-T1-WIRE-D

E1 mark no.: 02 A 3779  
Voltage : 12 Volt DC  
Power : 5W

Patent pending  
Europe Design protected  
EF-design: 002292524

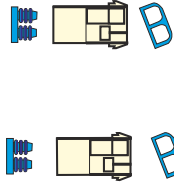

Connector/ sealing

Quantity=2



Cable tie  
120mm

Quantity=2



Installation manual  
UKJ20DAN\_T2\_LEDWHITE\_GL

Quantity=1

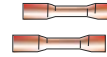

Solderless tube

Quantity=2

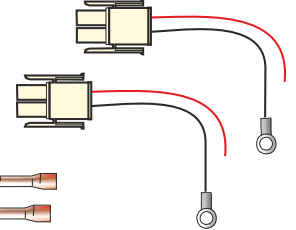

Connecting cable

Quantity=2

**Warranty void by any change or physical damage to the product**

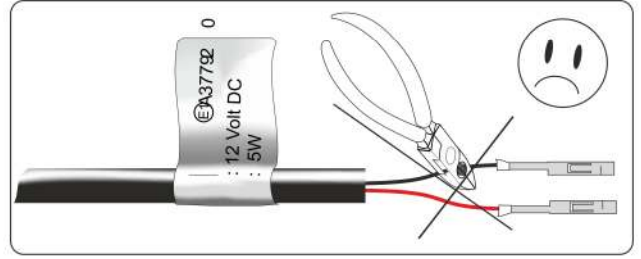
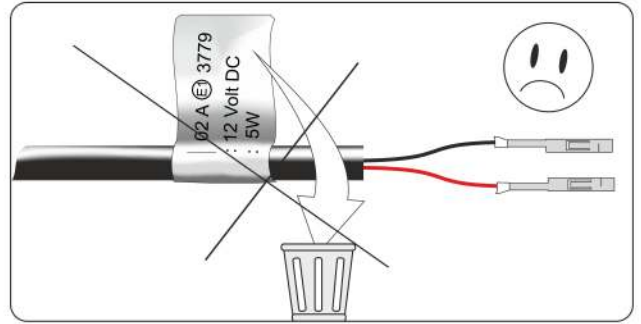
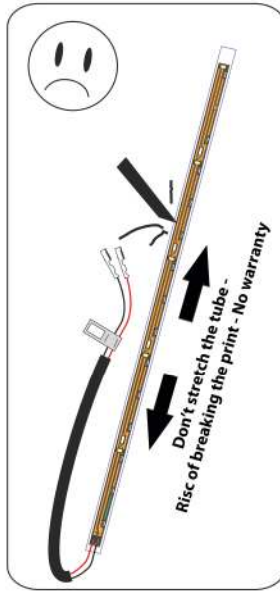
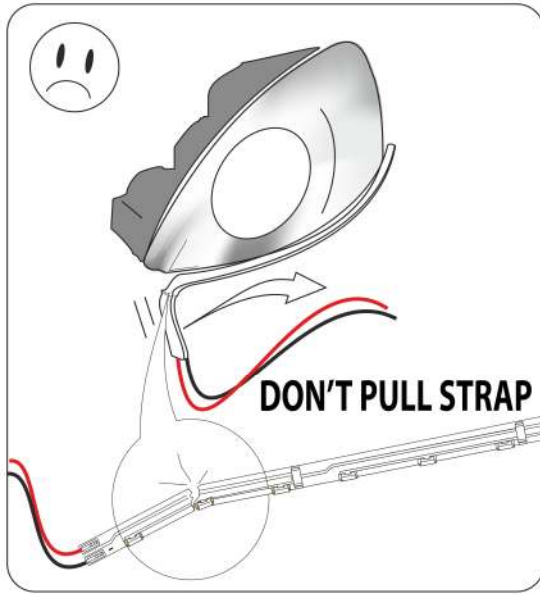

**Please observe before installation**

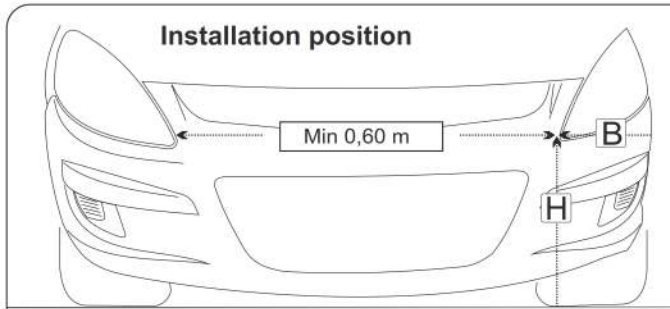
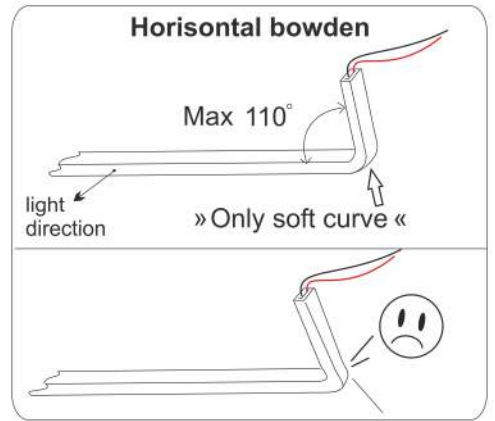
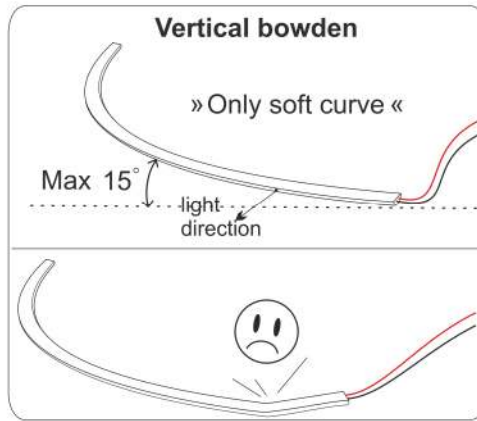
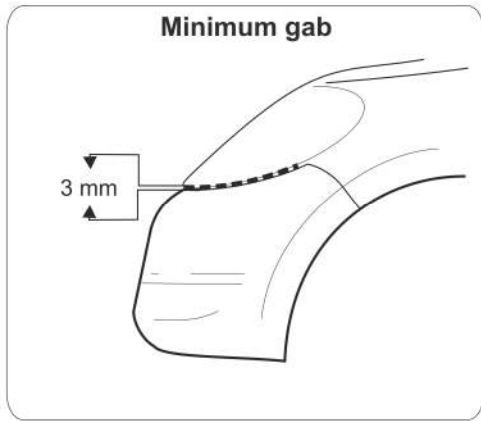

**H= Max 1,50 m  
Min 0,35 m**

**B= Max 0,40 m**

**ECE R48** §

This product refer to EU regulation ECE R48.  
The installer have the full responsibility of correct installation to the specific car.

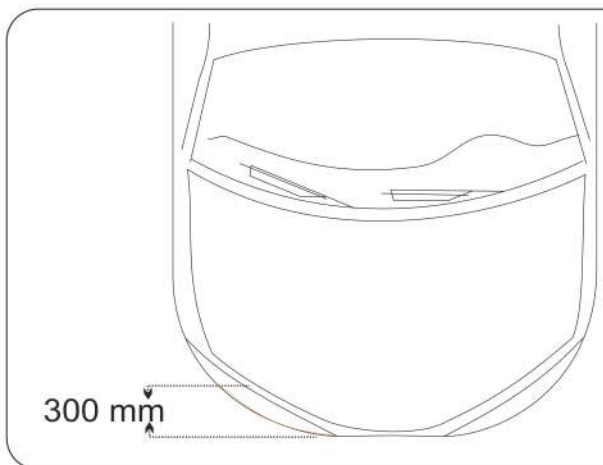

**Maximum curve**

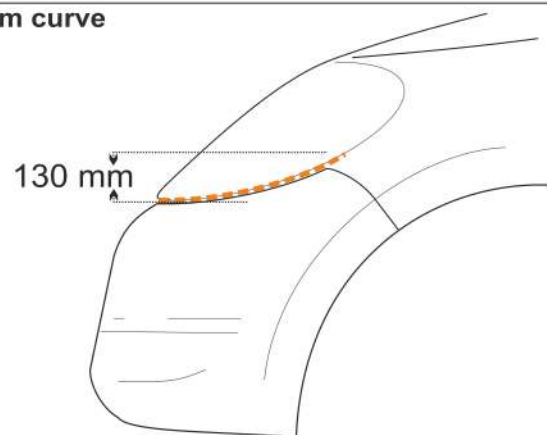

1

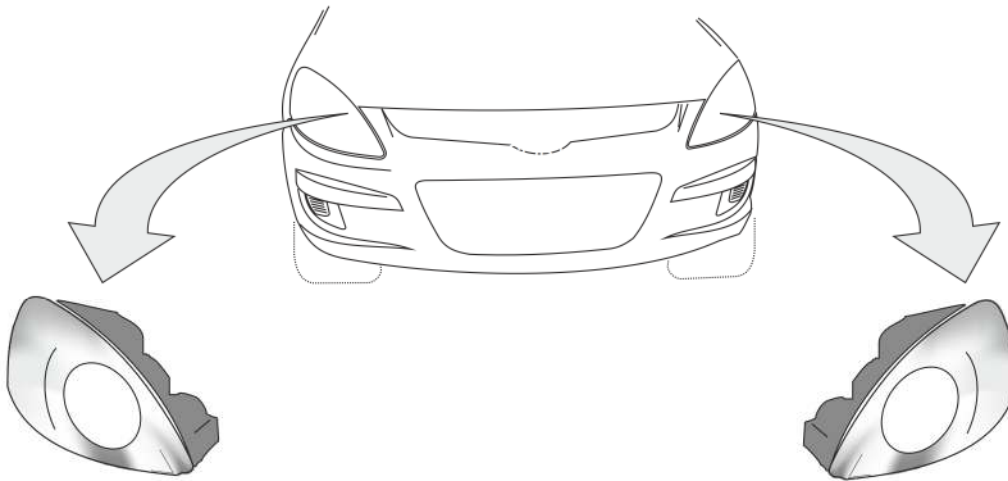

45 -60 Minutes



We recomand  
to let only  
professional  
installers  
perform the  
installation

2

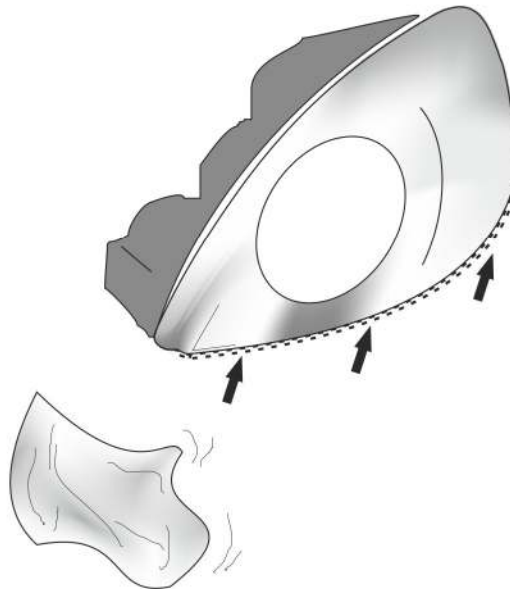

3

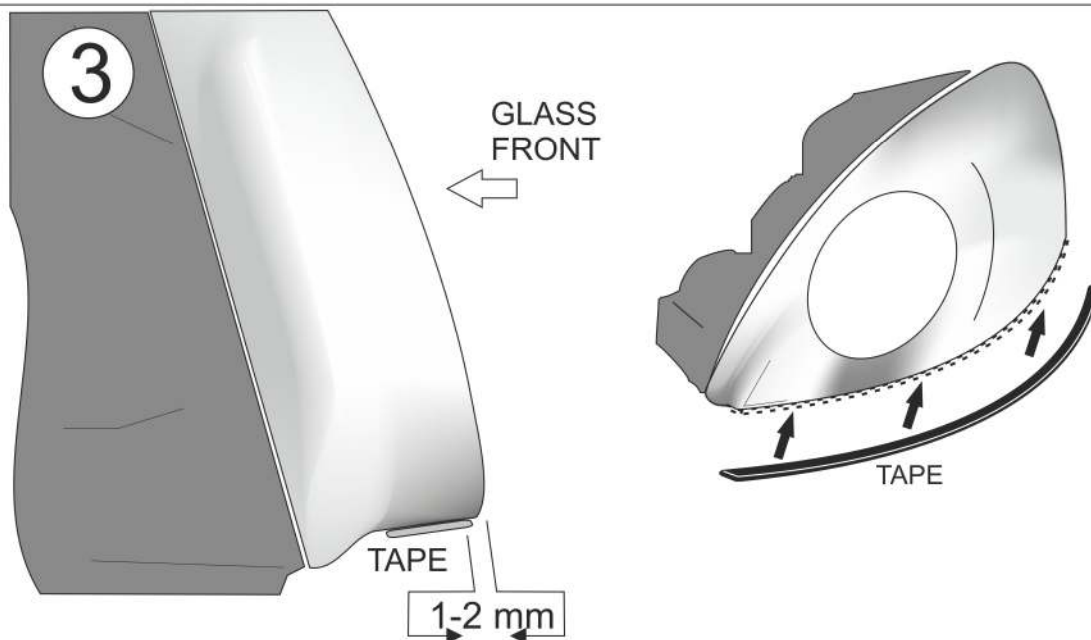

TAPE

4



**NOTE !** Observe light-direction on Led Strap before attachment.

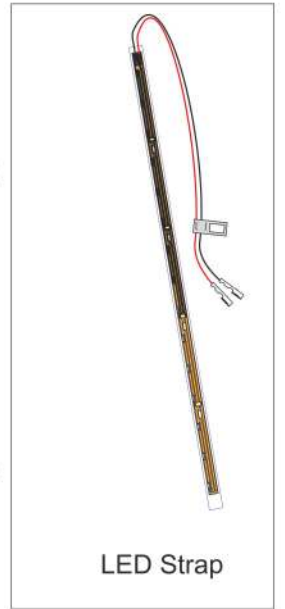
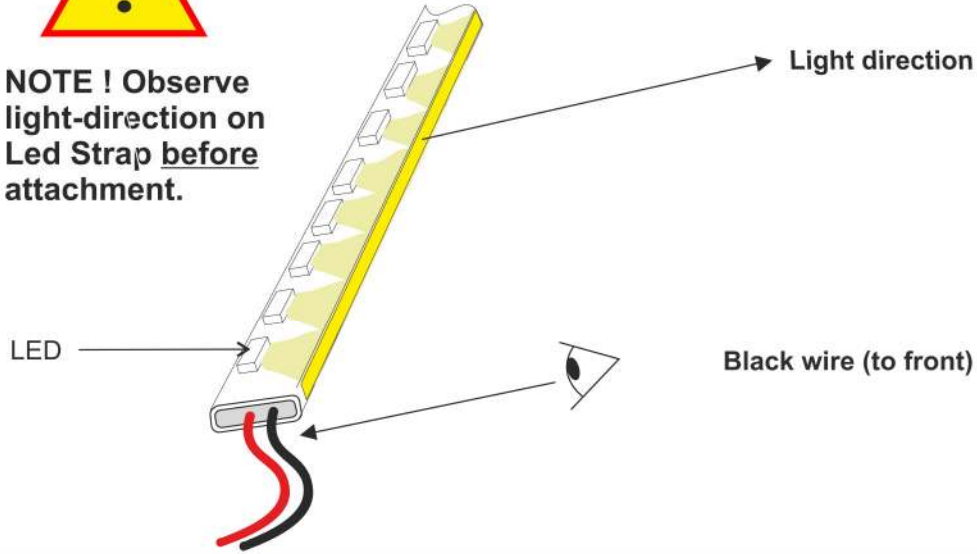

5

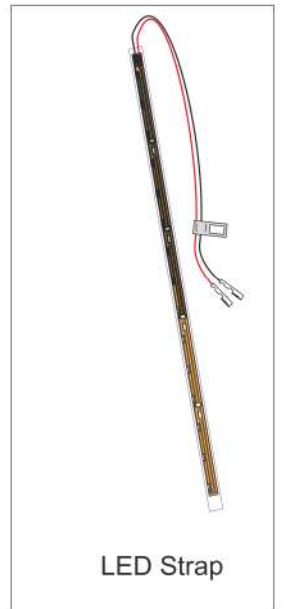
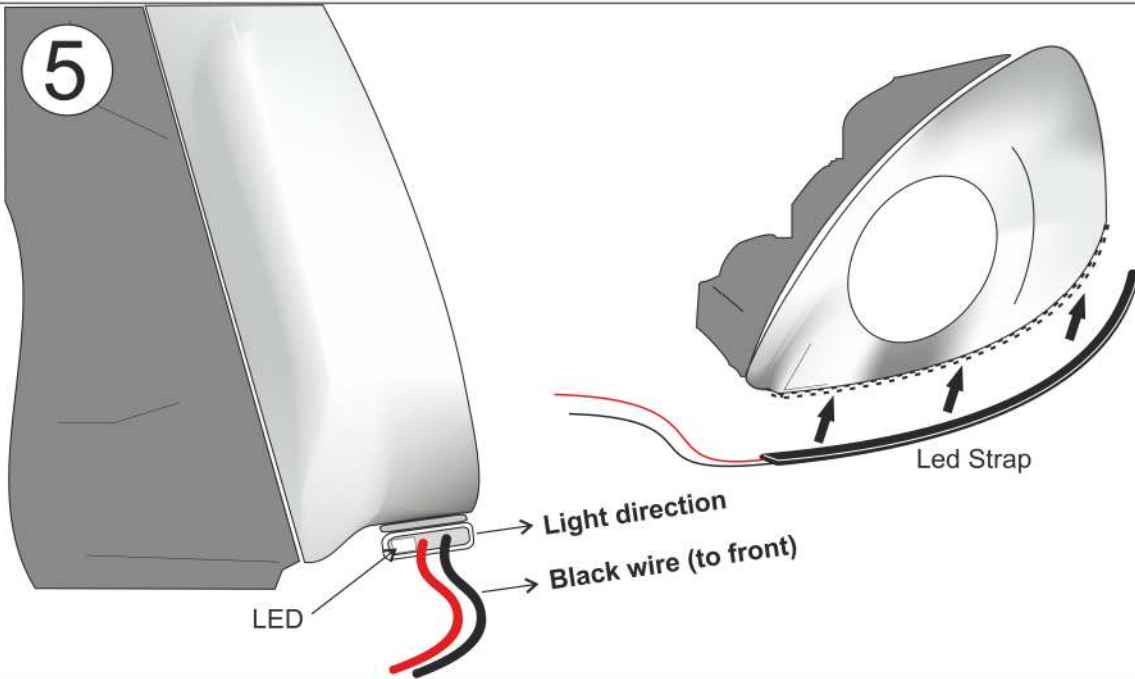

6

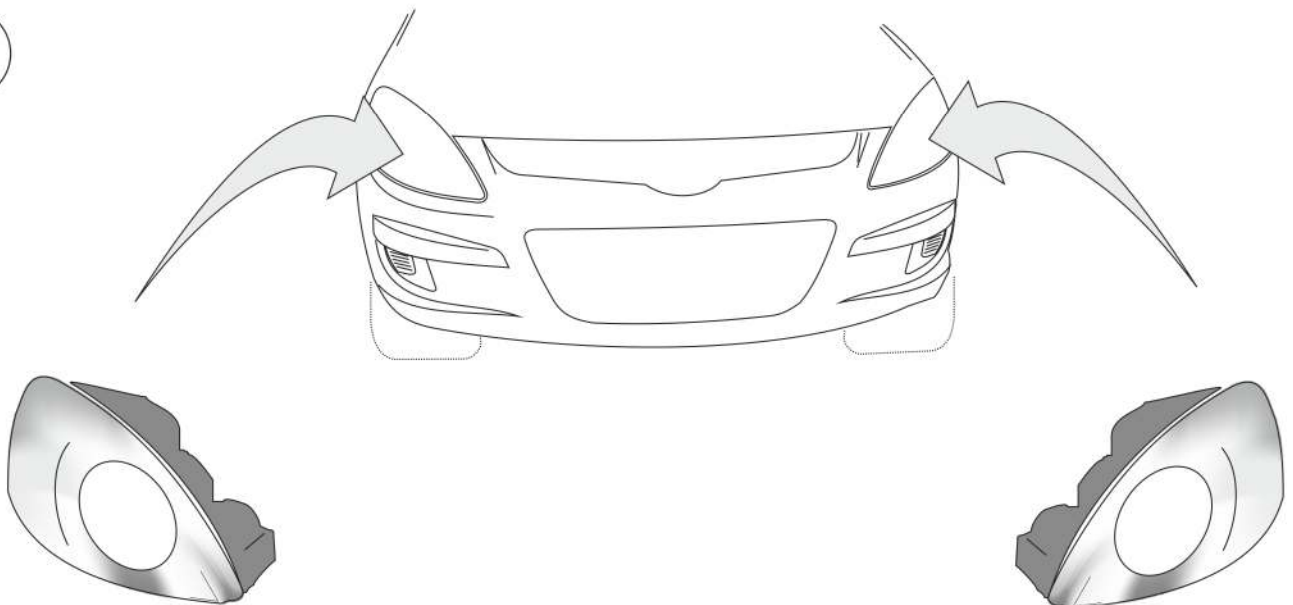

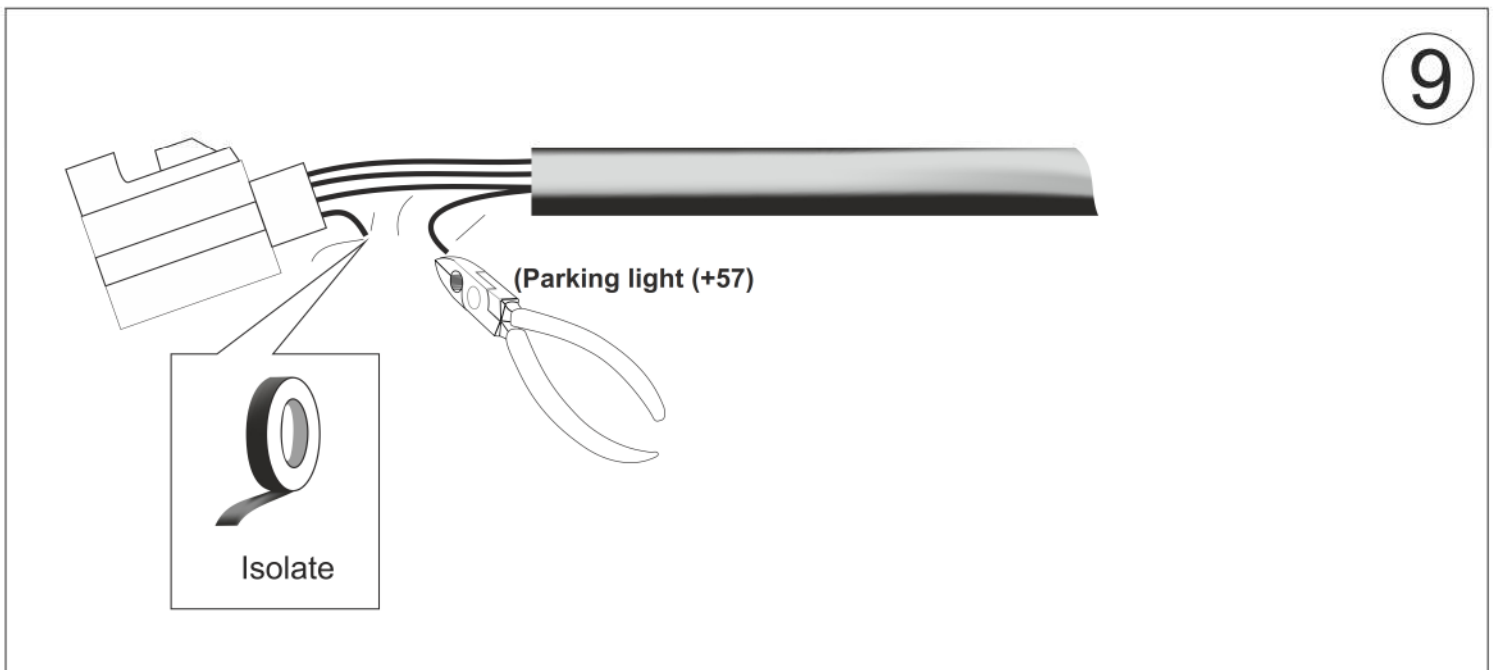
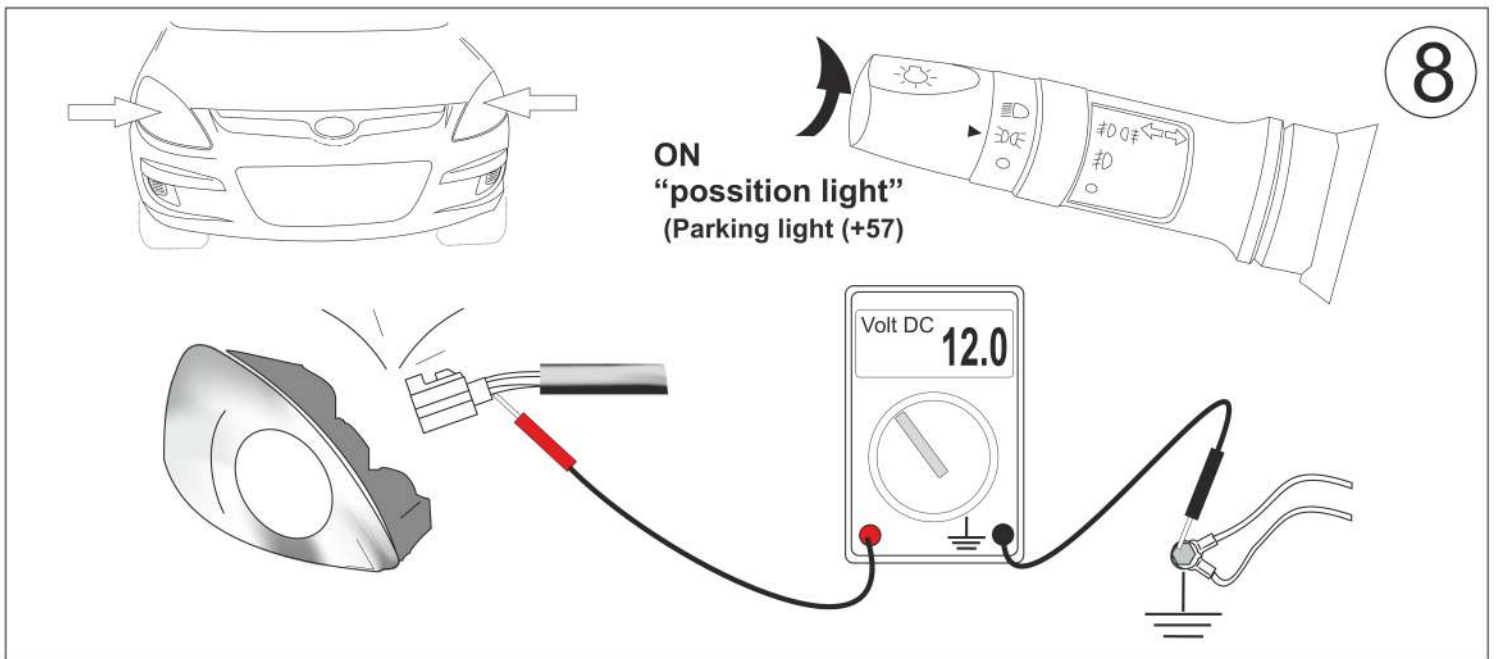
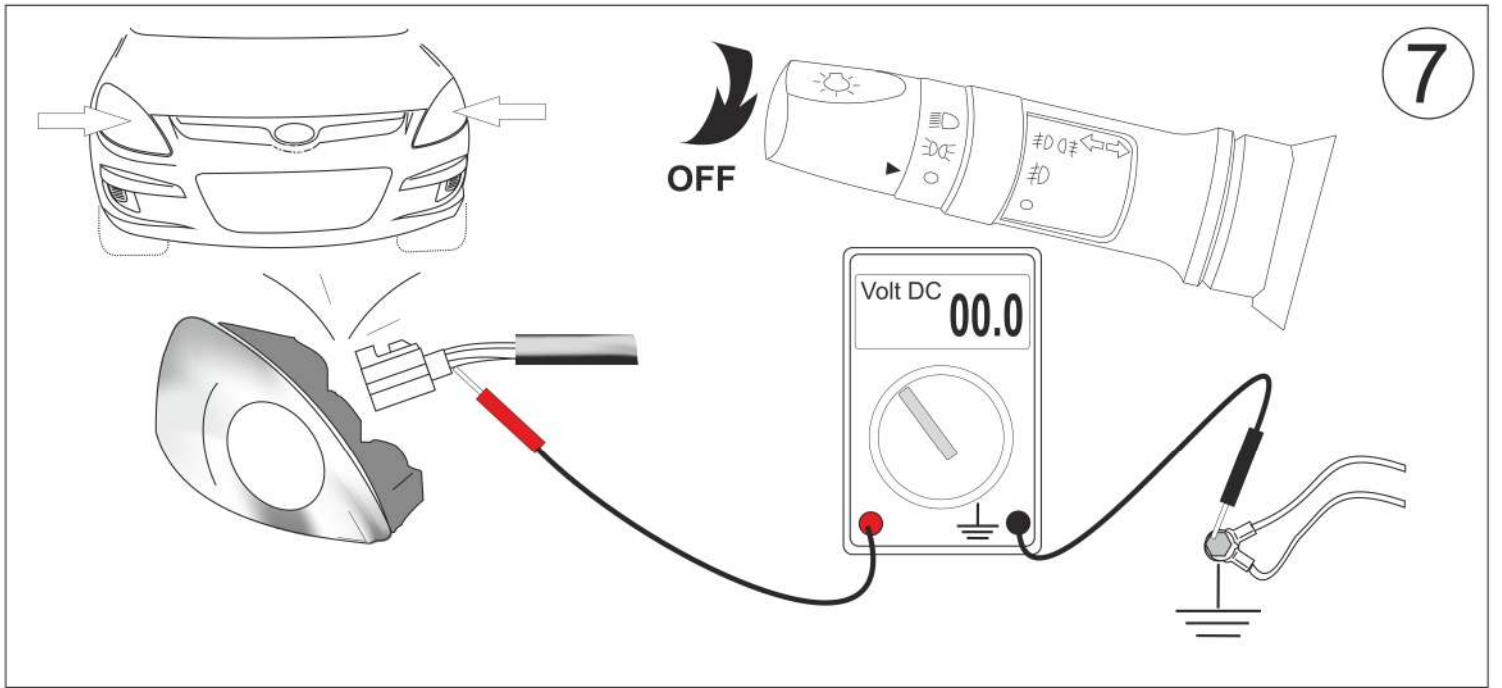

10

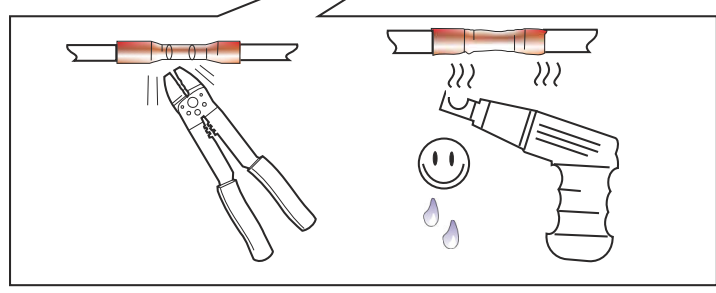
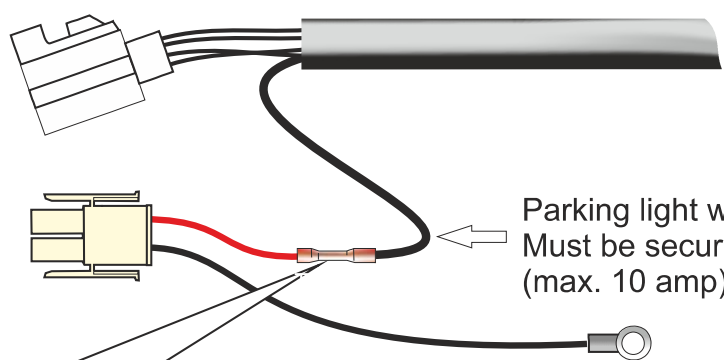

Connecting cable

Solderless tube

11

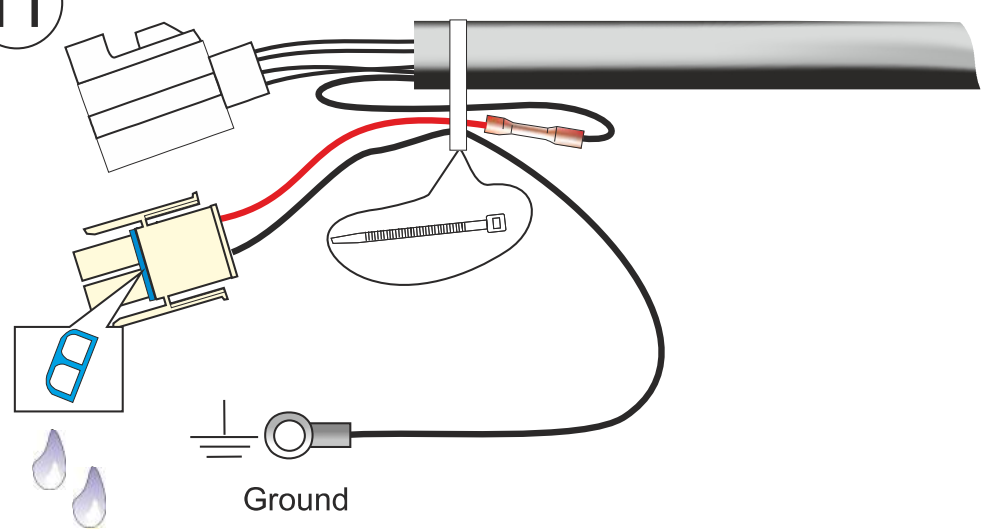

Sealing

Cable tie

12



Make **lable** always visible.  
Do not remove!

E mark no. : 02A © 3779  
Voltage : 12 Volt DC  
Power : 5W

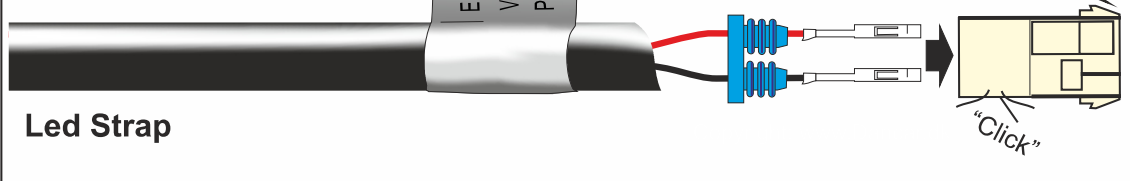

Led Strap

Sealing

Connector

13

AFTER INSTALLATION

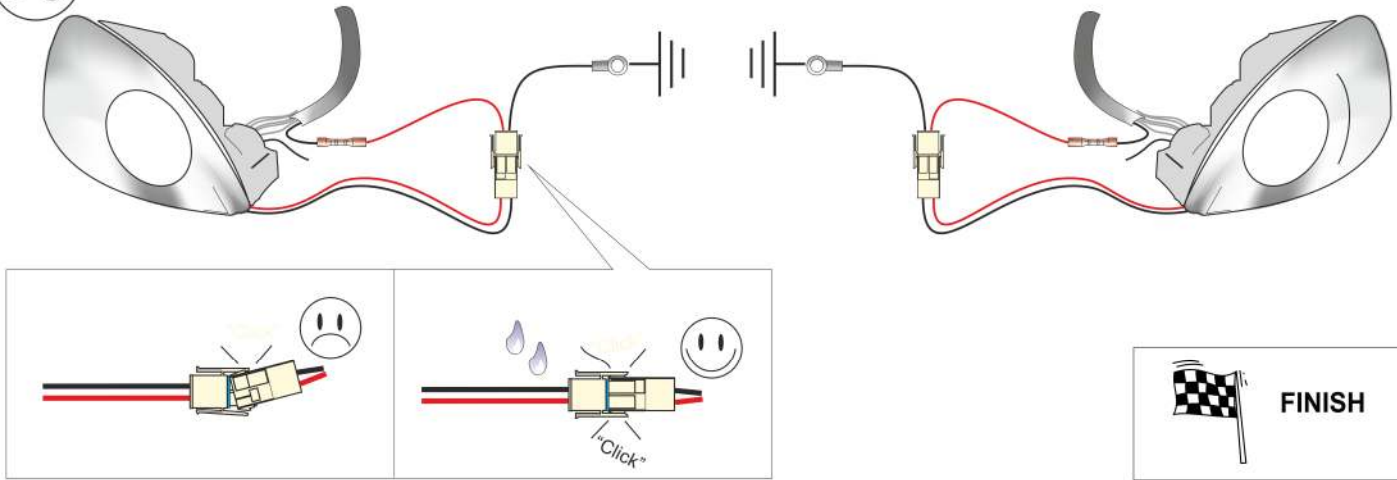

**Electrical connections:**

Red wire to be connected to positive side of vehicle circuit of (+54) position lamp. Black wire to be connected to (-31) Ground (battery negative).

**Attention:**

Some car types have fail monitoring of lamps. On this car type there will be a message in the fault information system of the car, since the original circuit is no longer present.

**Purpose of product:**

LED strap will be mounted **under-line** the original headlamp and will work as a substitute for front position lamp.

